

MCASE+™ Cartridge Fuses

Rated 32V

RoHS

Specifications

Voltage Rating:	32 V dc
Interrupting Rating:	1000A @ 32 V dc
Recommended Environmental Temperature:	-40 °C to +125 °C
Housing Material:	PPA-GF33 (U.L. 94 Flammability rating - HB)
Cover Material:	PA66 (U.L. 94 Flammability rating - V2)
Net Weight per Fuse:	1.15 g ± 10%
Fuse Insertion Force:	50N (11.2 lb) - Typical
Extraction Force:	4N Min. (0.9 lb) / 24.5N Max (5.5 lb) - Single Terminal
Complies with:	SAE 2741 and ISO 8820-4 in reference to electrical, mechanical and environmental performance requirements.



Features & Benefits

- Color coding shows the amperage rating for each fuse
- Semitransparent cover makes it easier to see when fuse blows
- Slotted fuses can mount on busbars
- High-contrast amperage stamp on the top of the housing aids identification
- High Temperature fuses clearly labeled “HT”

Applications

- Cars
- Trucks
- SUVs
- Offroad vehicles
- Buses
- Watercraft as approved by Littelfuse®

Description

MCASE+™ cartridge fuses protect automotive circuits from inrushes of current while taking up minimal space. Unslotted MCASE+ fuses mount on 2.8 mm terminals, and Slotted MCASE+ fuses can mount on busbars or 6.3 mm terminals. MCASE+ High Temperature fuses produce a lower voltage drop and experience a lower temperature rise when subjected to harsher conditions.

Note that the current carrying capability of the mating terminal must be verified to ensure proper system operation. Please contact Littelfuse for details regarding the test setup definition, which refers to ISO 8820-4 (Plated Mating Tab Terminals).

Ordering Information

Part Number	Type	Rating	Package Size
0695xxx.PXPS	Slotted	15–60	2000
0695xxx.PXPS-HT	Slotted	40–60	2000
0695xxx.PXP	Unslotted	15–40	2000
0695xxx.PXP-HT	Unslotted	40	2000



Recommended MCASE Fuse Puller
MATERIAL NUMBER 00970054XPA

MCASE+™ Cartridge Fuses

Rated 32V

Ratings

Part Number	Type	Current Rating (A)	Housing Material Color	Test Cable Size (mm ²)	Typ. Voltage Drop (mV)	Typ. Cold Resistance (mΩ)	Typ. I ² t (A ² s)
0695015.PXPS	Slotted	15	Grey	1.25	97	4.8	295
0695020.PXPS	Slotted	20	Blue	1.25	100	3.4	570
0695025.PXPS	Slotted	25	Orange	2	99	2.5	1370
0695030.PXPS	Slotted	30	Pink	2	112	1.8	1030
0695040.PXPS	Slotted	40	Green	3	107	1.1	1400
0695050.PXPS	Slotted	50	Red	5	109	0.77	3800
0695060.PXPS	Slotted	60	Yellow	5	102	0.54	8000
0695040.PXPS-HT	Slotted	40	Green	3	111	0.89	2500
0695050.PXPS-HT	Slotted	50	Red	5	74	0.64	5700
0695060.PXPS-HT	Slotted	60	Yellow	5	90	0.46	13 000
0695015.PXP	Unslotted	15	Grey	1.25	97	4.8	300
0695020.PXP	Unslotted	20	Blue	1.25	106	3.4	600
0695025.PXP	Unslotted	25	Orange	2	114	2.5	1200
0695030.PXP	Unslotted	30	Pink	2	96	1.8	1000
0695040.PXP	Unslotted	40	Green	3	101	1	1700
0695040.PXP-HT	Unslotted	40	Green	3	109	0.89	2500

Please Note: The performance of the male terminal is critical to ensuring the fuse will function as designed. The current carrying capability of the mating terminal must be verified to ensure proper system operation. Fixture Test Set Up Refer To ISO 8820 4 (Plated Mating Tab Terminals). Please contact Littelfuse® for details regarding Test Set Up Definition.

The typical I²t is an average value calculated from the breaking capacity tests by using the melting time before the arcing occurs.

MCASE+™ Cartridge Fuses

Rated 32V

Dimensions

Dimensions in mm for reference only.
See outline drawing for dimensions and tolerances.

MCASE+™ Slotted

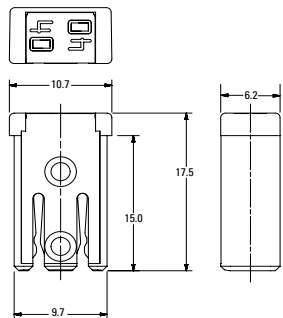

MCASE+™ Slotted HT

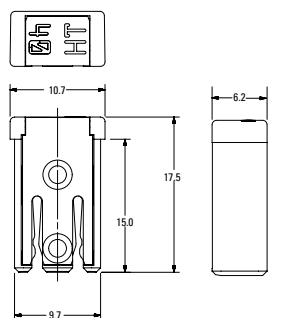

MCASE+™ Unslotted

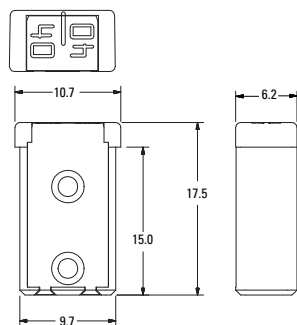

MCASE+™ Unslotted HT

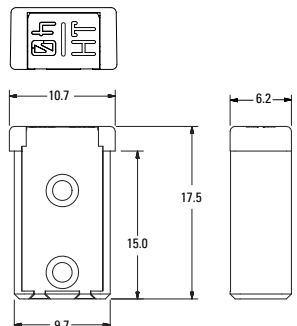

Slotted Recommended Mating Cavity

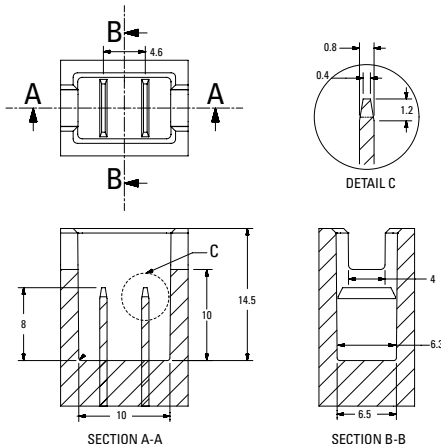

Unslotted Recommended Mating Cavity

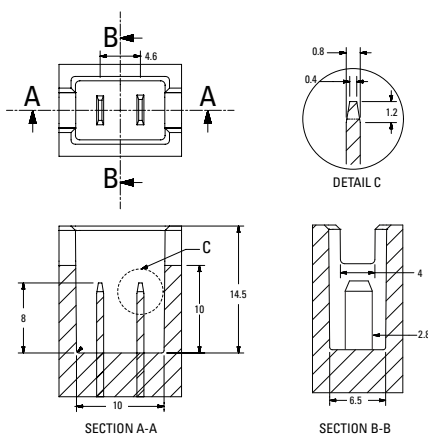

MCASE+™ Cartridge Fuses

Rated 32V

MCASE+™ Slotted

Time-Current Characteristic Curves

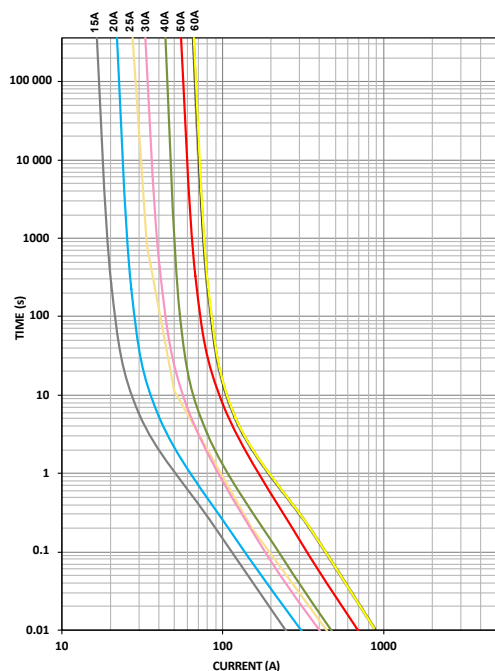

Time-Current Characteristics

% of Rating	Opening Time Min / Max (s)
110	360 000 / ∞
135	60 / 1800
200	2 / 60
350	0.2 / 7
600	0.04 / 1

Typical Derating of Fuse Melting Element

Temperature Security Margin is 20%
 Wire Cross Section And Fixture Test Set Up Refer To ISO 8820-3
 Please Contact Littelfuse® For Details Regarding Derating Test Set Up

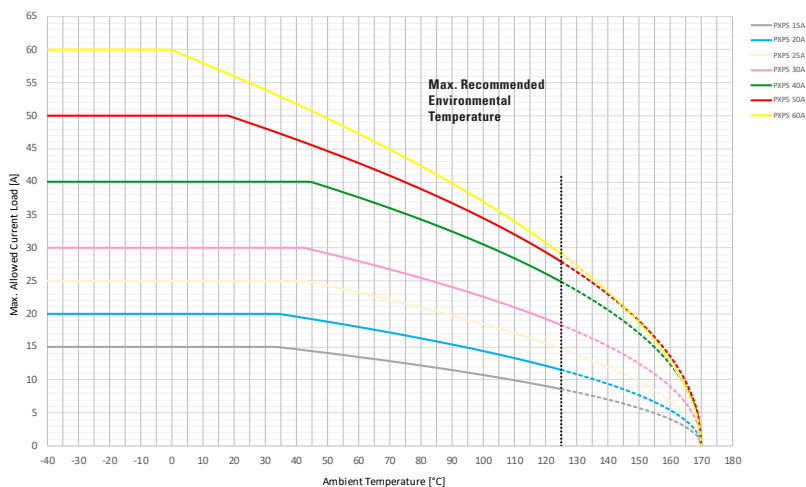

Temperature Table

	Max. allowed current load (A) at ambient temperature (typical derating)						
	-40 °C	0 °C	20 °C	65 °C	85 °C	110 °C	125 °C
15A	15	15	15	13	12	10	9
20A	20	20	20	18	16	13	12
25A	25	25	25	23	20	17	15
30A	30	30	30	27	25	21	18
40A	40	40	40	37	33	28	25
50A	50	50	50	42	38	32	28
60A	60	60	56	46	41	34	29

Derating curves may change depending on the final condition of the application (terminals characteristics, wire size etc.). Please ask Littelfuse for more information.

MCASE+™ Cartridge Fuses

Rated 32V

MCASE+™ Slotted HT

Time-Current Characteristic Curves

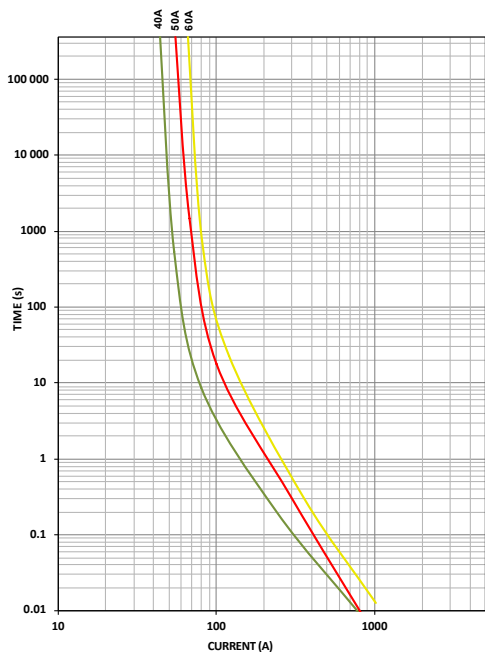

Time-Current Characteristics

% of Rating	Opening Time Min / Max (s)
110	360 000 / ∞
135	60 / 1800
200	2 / 60
350	0.2 / 7
600	0.04 / 1

Typical Derating of Fuse Melting Element

Temperature Security Margin is 20%
 Wire Cross Section And Fixture Test Set Up Refer To ISO 8820-3
 Please Contact Littelfuse® For Details Regarding Derating Test Set Up

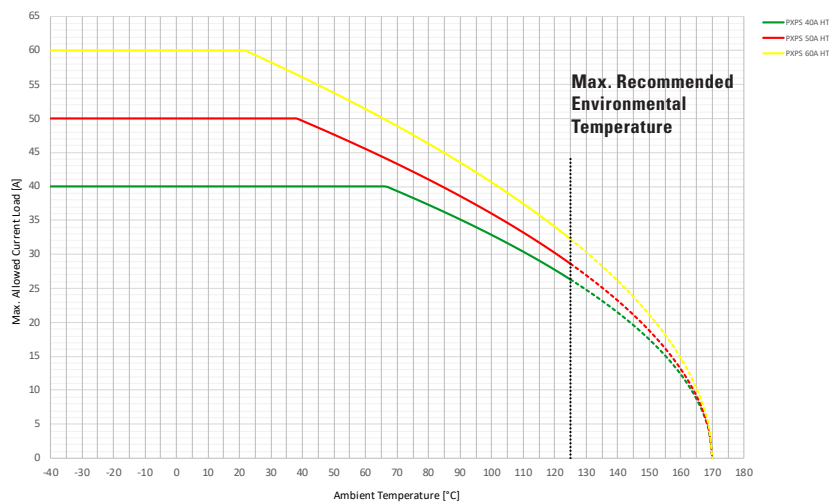

Temperature Table

	Max. allowed current load (A) at ambient temperature (typical derating)						
	-40 °C	0 °C	20 °C	65 °C	85 °C	110 °C	125 °C
40A HT	40	40	40	40	36	30	26
50A HT	50	50	50	44	40	33	29
60A HT	60	60	60	50	45	37	32

Derating curves may change depending on the final condition of the application (terminals characteristics, wire size etc.). Please ask Littelfuse for more information.

MCASE+™ Cartridge Fuses

Rated 32V

MCASE+™ Unslotted

Time-Current Characteristic Curves

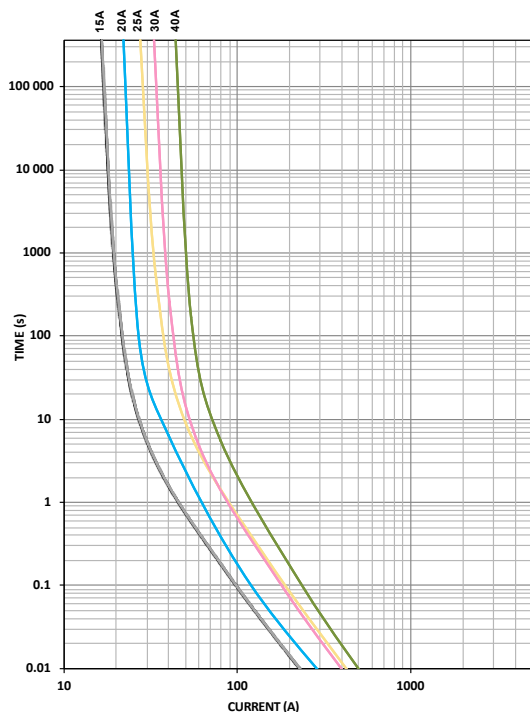

Time-Current Characteristics

% of Rating	Opening Time Min / Max (s)
110	360 000 / ∞
135	60 / 1800
200	2 / 60
350	0.2 / 7
600	0.04 / 1

Typical Derating of Fuse Melting Element

Temperature Security Margin is 20%
 Wire Cross Section And Fixture Test Set Up Refer To ISO 8820-3
 Please Contact Littelfuse® For Details Regarding Derating Test Set Up

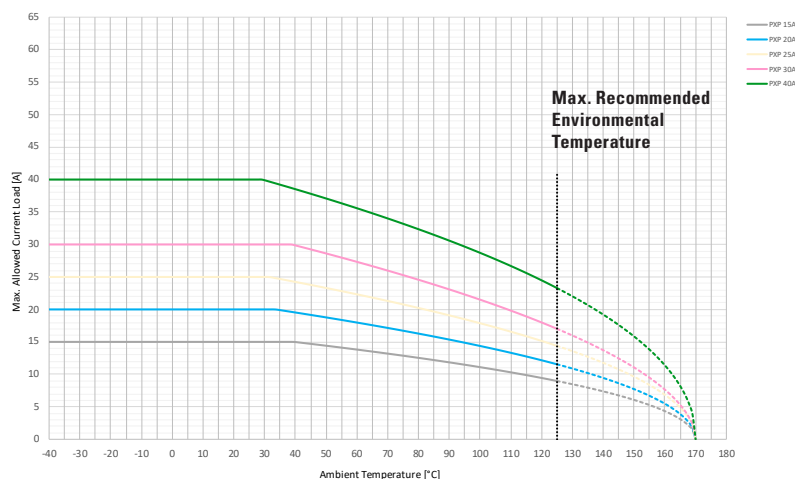

Derating curves may change depending on the final condition of the application (terminals characteristics, wire size etc.). Please ask Littelfuse for more information.

Temperature Table

	Max. allowed current load (A) at ambient temperature (typical derating)						
	-40 °C	0 °C	20 °C	65 °C	85 °C	110 °C	125 °C
15A	15	15	15	14	12	10	9
20A	20	20	20	18	16	13	12
25A	25	25	25	22	20	17	14
30A	30	30	30	27	24	20	17
40A	40	40	40	35	31	27	23

MCASE+™ Cartridge Fuses

Rated 32V

MCASE+™ Unslotted HT

Time-Current Characteristic Curves

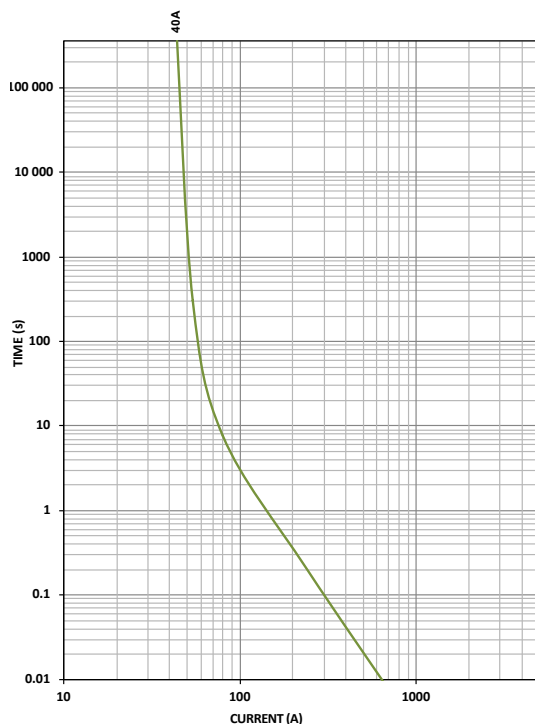

Time-Current Characteristics

% of Rating	Opening Time Min / Max (s)
110	360 000 / ∞
135	60 / 1800
200	2 / 60
350	0.2 / 7
600	0.04 / 1

Typical Derating of Fuse Melting Element

Temperature Security Margin is 20%
 Wire Cross Section And Fixture Test Set Up Refer To ISO 8820-3
 Please Contact Littelfuse® For Details Regarding Derating Test Set Up

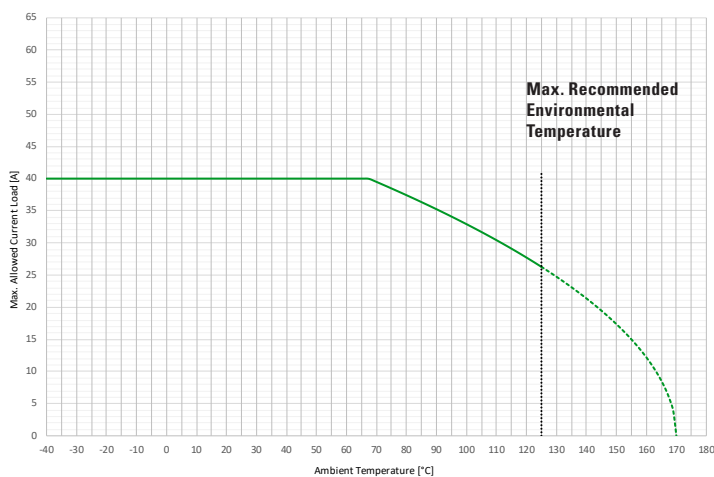

Derating curves may change depending on the final condition of the application (terminals characteristics, wire size etc.). Please ask Littelfuse for more information.

Temperature Table

	Max. allowed current load (A) at ambient temperature (typical derating)						
	-40 °C	0 °C	20 °C	65 °C	85 °C	110 °C	125 °C
40A HT	40	40	40	40	36	30	26